



VFS100-SS  
REFRIGERATOR



**VEZENI**



**THANK YOU**

---

**FOR YOUR PURCHASE**

**VFS100-SS | REFRIGERATOR**

# Table of Contents

## Warning

Warnings-----	2
---------------	---

## Safety and Warning Information

Basic safety symbol-----	5
Appliance connection -----	5
Safety and warning information-----	5

## Product Introduction

Product features-----	9
Product components-----	10
Installation dimension-----	11

## Installation

Transportation-----	12
Where to install your unit-----	12
Adjustable plastic feet-----	12

## Operation

Before use -----	13
Starting -----	13
Control panel -----	14
Freezer temperature controls-----	15
Fridge temperature controls-----	15
Refrigerator chamber -----	17
Freezing chamber -----	18
Food storage tips -----	19
Energy-saving-----	19

## Maintenance

Defrosting-----	20
Cleaning -----	20
General information -----	20
Normal phenomena -----	21
Troubleshooting -----	22

## Warning

The refrigerant isobutene(R600a) is contained within the refrigerant circuit of the appliance, a natural gas with a high level of environmental compatibility, which is nevertheless flammable.

During transportation and installation of the appliance, ensure that none of the components of the refrigerant circuit becomes damaged.

The refrigerant (R600a) is flammable.



Symbol ISO 7010 W021 Warning;  
Risk of fire/flammable materials

1. WARNING: The appliance must be positioned so that the plug is accessible.
2. WARNING: If the supply cord is damaged, it must be replaced by the manufacturer, its service agent or similarly qualified persons in order to avoid a hazard.
3. WARNING: Keep ventilation openings, in the appliance enclosure or in the built-in structure, clear of obstruction.
4. WARNING: Do not use mechanical devices or other means to accelerate the defrosting process, other than those recommended by the manufacturer.
5. WARNING: Do not damage the refrigerant circuit.
6. WARNING: Do not use electrical appliances in side the food storage compartments of the appliance, unless they are of the type recommended by the manufacturer.

## Warning

7.WARNING: This unit is using R600a as the Refrigerant and cyclopentane as Foaming agent, both of this two kind of material is easy to be burnt, so the abandoned unit should be away from the fire, and can not be treated with fire.

8.WARNING: Danger of electrical shock, the yellow-green earthing of this appliance must be earthed before operation.

9. WARNING: Refrigerator discarded after the need for disposal according to local laws and regulation.

10.WARNING: The refrigerant and insulation blowing gas are flammable. When disposing of the appliance, do so only at an authorized waste disposal center. Do not expose to flame.

11.WARNING: When positioning the appliance, ensure the supply cord is not trapped or damaged.

12.WARNING: Do not locate multiple portable socket-outlets or portable power supplies at the rear of the appliance.

13.WARNING: To avoid contamination of food, please respect the following instructions.

- Opening the door for long periods can cause a significant increase of the temperature in the compartments of the appliance.
- Clean regularly surfaces that can come in contact with food and accessible drainage systems.
- Store raw meat and fish in suitable containers in the refrigerator, so that it is not in contact with or drip onto other food.

14.WARNING: Risk of child entrapment. Before you throw away your old refrigerator or freezer:

- Take off the doors
- Leave the shelves in place so that children may not easily climb inside.

## Warning

- Before performing any type of installation or cleaning, disconnect the refrigerator from the electrical source. When you are finished, reconnect the refrigerator to the electrical source and reset the temperature controls to the desired setting.
- If the led light is damaged, it must be replaced by the manufacturer, its service agent or similarly qualified persons in order to avoid a hazard.
- Before installing the water supply line, you will need :
  - WARNING: fill with potable water only.The water supply system must be installed and connected by a professional technician. Connect the refrigerator with the cold water pipe:
  - the maximum inlet water pressure is 690kPa;
  - the minimum inlet water pressure is 140kPa.WARNING: Connect to potable water supply only.
- The new hose-sets supplied with the appliance are to be used and that old hose-sets should not be reused.



This symbol on the product or in its packing indicates that this product may not be treated as household waste. Instead, it should be taken to the appropriate waste collection point for the recycling of electrical and electronic equipment. By ensuring this product is disposed of correctly, you will help prevent potential negative consequences for the environment and human health, which could otherwise be caused by the inappropriate waste handling of this product. For more detailed information about the recycling of this product, please contact your local council, your household waste disposal service, or the shop where you purchased the product.

# Safety and warning information

## Basic safety symbol

This guide contains many important safety messages. Always read and obey all safety messages.



This is the safety alert symbol. It alerts you to safety messages that inform you of hazards that can kill or hurt you or others or cause damage to the product. All safety messages will be preceded by the safety alert symbol and the hazard signal word DANGER, WARNING, or CAUTION. These words mean:



You will be seriously injured if you don't follow the instructions.



You will be seriously injured if you don't follow the instructions.



Indicates an imminently hazardous situation which, if not avoided, may result in minor or moderate injury, or product damage only.

## Appliance connection



The appliance is applicable to 115/60Hz only, and the allowable voltage fluctuation range is 98~132V.

In order to ensure safety, the socket and its cable must be able to withstand the current of above 15A.

## Safety and warning information

To reduce the risk of fire, electric shock, or injury to persons when using your product, basic safety precautions should be followed, including the following.

Read all instructions before using this appliance.

# Safety and warning information

## Safety and warning information

### WARNING

Do not damage the refrigerant circuit.

Refrigerant will cause serious injury when it splashing into the eyes. If it happened please go to hospital immediately.

Keep ventilation openings, in the appliance enclosure or in the built-in structure, clear of obstruction.

Do not use electrical appliance inside the food storage chambers of the appliance, unless they are of the type recommended by the manufacturer.

Do not use mechanical devices or other means to accelerate the defrosting process, other than those recommended by the manufacturer.

The refrigerant and insulation blowing gas are flammable. When disposing of the appliance, do so only at an authorized waste disposal center. Do not expose to flame.

### CAUTION

This appliance is not intended for use by persons (including children) with reduced physical, sensory or mental capabilities, or lack of experience and knowledge, unless they have been given supervisor or instruction concerning use of the appliance by a person responsible for their safety.

Children should be supervised to ensure that they do not play with the appliance.

### DANGER

Do not use or store inflammable materials ether, benzene, alcohol, medicine, LP gas, spray or cosmetics near or in the fridge. It may cause explosion or fire.

Do not put glassware in freezing chamber or refrigerator chamber air outlet, it may cause explosion or hurt.

Make sure of grounding.

Consult a qualified electrician or service person if the grounding instructions are not completely understood, or if you have doubts on whether the appliance is properly grounded.

The incorrect grounding may cause breakdown and electric shock.

Do not store explosive substances such as aerosol cans with a flammable propellant in this appliance.

This appliance is intended to be used in household and similar applications such as

- staff kitchen areas in shops, offices and other working environments;
- farm houses and by clients in hotels, motels and other residential type environments;
- bed and breakfast type environments;
- catering and similar non-retail applications.



# Safety and warning information

## Safety and warning information

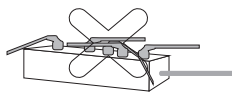

- The dedicated outlet should be used. Using several devices at one outlet may cause fire.

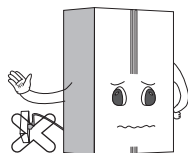

- Install the appliance in a dry, well ventilated room.
- The appliance should be placed close to socket, it is easy to cut off the power supply at the time of the accident.



- Do not allow the power plug to face upward or to be squeezed at the back of the fridge. Water may be flown into or the plug may be damaged, which causes fire or electric shock.



- Do not allow the power cord bent or pressed by the heavy object to be damaged. If it is damaged, it must be replaced by the service agent or a similarly qualified person in order to avoid a hazard.

If the supply cord is damaged, it must be replaced by the manufacturer, its service agent or similarly qualified persons in order to avoid a hazard.

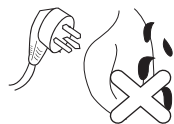

- Unplug the power plug when cleaning, handling the interior lamp of the fridge.

It may cause electric shock or injury.

If the LED lamp is damaged, it must be replaced by the manufacturer, its service agent.

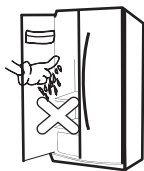

- Remove water or dust from the power plug with dry clean cloth, do not use wet hands touch it and insert it with the ends of the pins securely connected.

- Do not touch food or containers at the freezer with wet hands. It may cause frostbite.

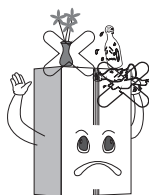

- Do not place the heavy object or the dangerous object, cup, flower vase, cosmetics, medicine or any container with water on the fridge.

It may be dropped to cause injury, fire or electric shock when opening or closing the door.

- Do not spray water at the outside or the inside of the fridge or do not clean it with benzene or thinner.

# Safety and warning information

## Safety and warning information



- Wait for 5 minutes or longer when reconnecting the plug. It may cause the operation of the freezer to fail.
- Do not use the fridge for non-domestic purpose (storing medicine or testing material, blood, near water, etc.) It may cause an unexpected risk such as fire, electric shock, deterioration of stored material or chemical reaction.

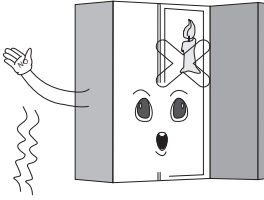

- Do not use drier to dry the inside, nor light a candle to remove odor. It may cause explosion or fire.
- Do not cling to the door or the trays of the door. It may make the fridge fall down or damage the hands. Especially, do not allow the children to do the above.

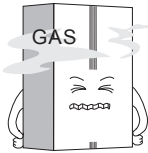

- When gas is leaked, do not touch the fridge or the outlet and ventilate the room immediately. The explosion by spark may cause fire or burn. When the gas is leaked by the severe damage during delivering, installing or using the fridge, any spark may cause fire or burn.

- Do not insert the hands or the metal stick into the exit of cool air, the cover, the bottom of the fridge, the heatproof grill (exhaust hole) at the backside. It may cause electric shock or injury.

- Do not put ice in thin crystal cup or ceramic ware. It may break cup or ceramic ware to cause injury.

- If the supply cord is damaged, it must be replaced by the manufacturer, its service agent or similarly qualified persons in order to avoid a hazard.

- Use the submerged the fridge after checking it. It may cause electric shock or fire.

- Do not install the fridge in the wet place or the place which water or rain splashes. Deterioration of insulation of electric parts may cause electric leakage. Please check the fridge regularly.

- Do not allow any person except the qualified engineer to disassemble, repair or alter the fridge. It may cause injury, electric shock or fire.

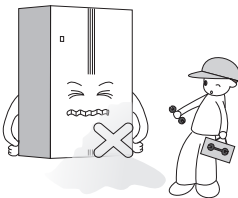

# Product Introduction

## Product features

- **Energy saving and noise reduction**  
It contains super freeze, energy saving, noise reduction, optimal refrigeration system to achieve.
- **Precise temperature control**  
Microcomputer control system separate to set, control and display the R-temperature and F-temperature, more precise control.
- **Automatic defrosting**  
Special program to reduce the temperature fluctuation of the fridge, it's for keeping food fresh.
- **LED display and touch button**  
Control board respectively display refrigerator and freezer chamber temperature setting and functional status; touch button operation is convenient.
- **Door-opening alarm system**  
If more than 1 minute door-opening, alarm system will remind you to close the door.
- **Tempered glass, safe and reliable**  
Tempered glass, safe and reliable, easy clean and durable.
- **Easy clean and removable door seal**  
Door seal is easy clean and removable, and long service life.
- **Automatic ice maker**  
The refrigerator has the function of automatic ice making, and users can take ice cube, crushed ice and cold water outside the door.

# Product Introduction

## Product components

All figures in this manual are schematic; some features and devices may not be consistent fully with your refrigerator and the specific structure and configuration shall be subject to the actual product.

The appearance and specifications of the actual product may differ depending on the model.

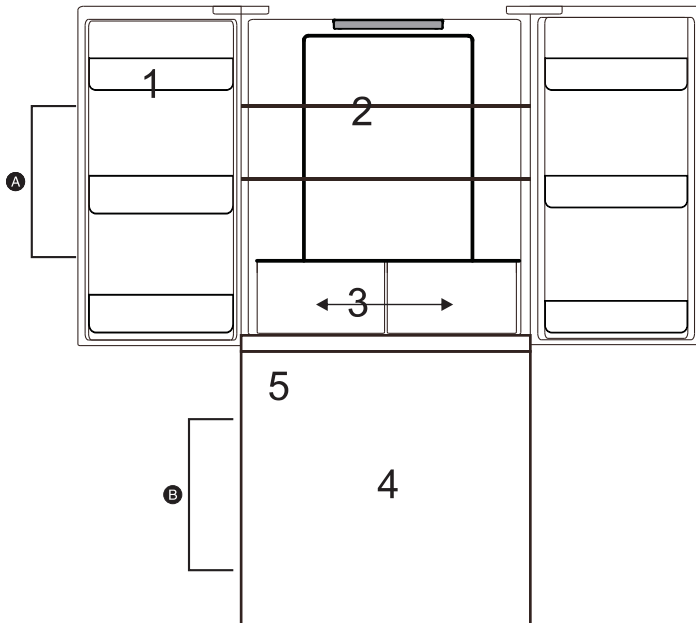

A Refrigerator compartment

B Freezer compartment

- 1 Refrigerator door rack
- 2 Refrigerator glass shelves
- 3 Crisper drawers

- 4 Freezer drawer
- 5 Ice maker

# Product Introduction

## Installation dimension

Select a good location to place your appliance where it is flat and easy to use. Avoid placing the unit near heat sources, direct sunlight or moisture.

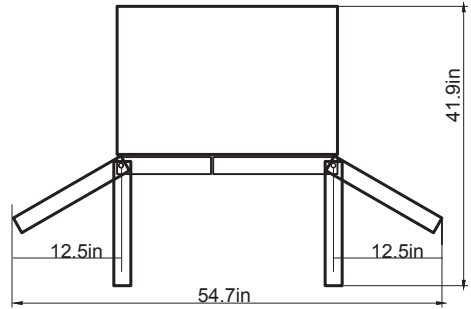
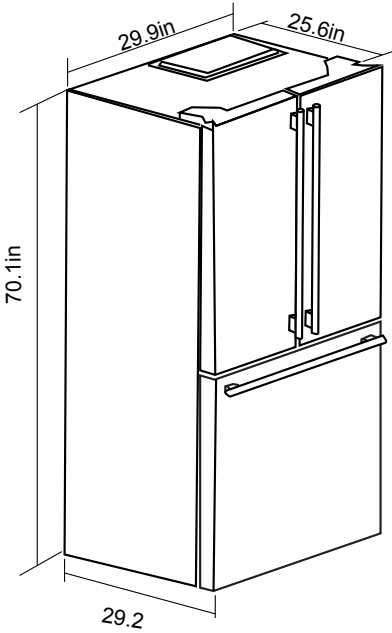

- The figure above is schematic for installation only, not representing the actual product. The specific dimension shall be subject to the product that you have bought.
- To ensure proper air circulation around the fridge, please maintain sufficient space. If install the top panel or closet, please maintain sufficient space to move when necessary.

# Installation

## Transport



- Do not carry the refrigerator horizontally or reversely.
- Do not carry the refrigerator by holding the door or handle; the refrigerator shall be carried by lifting the bottom.

## Place environment

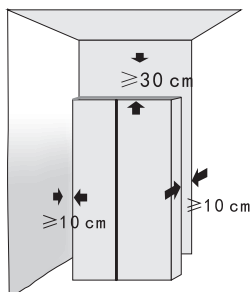

- The refrigerator must be placed on a hard, flat ground; if cushioning is needed, stable, hard, nonflammable cushion blocks shall be used, rather than the foam backing of refrigerator.
- The refrigerator shall be kept away from damp locations where water is easy to splash; water or dirt shall be removed with soft cloth timely to prevent rusting which may have an effect on the electrical characteristics.
- Place the refrigerator in a well-ventilated place, reserve a certain space around and behind the refrigerator, and do not cover or block the air grille on the rear cover plate of compressor at the back of refrigerator; Keep the refrigerator away from heat source or direct sunlight.

## Adjust plastic feet

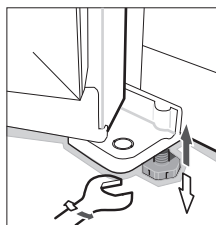

- When the refrigerator stays in the packing box, plastic feet are in tightened state. After carrying it out from the packing box for placement, please make sure to adjust two front plastic feet until the height is suitable; just adjust two plastic feet with a wrench or directly by hand.
- Plastic feet and rear rollers must touch the ground to prevent the refrigerator from movement, vibration or noise. When moving the refrigerator, adjust plastic feet counterclockwise to keep them off the ground, and then push the refrigerator gently to move it.

# Operation

## Before Using

- Remove all packages, including the foam backing at the bottom of refrigerator and the tapes fixing accessories in the box.
- Place the refrigerator to a proper position, and adjust the feet to level. It is better to clean the refrigerator before use.
- Remove the film: There is a layer of transparent film on the panel of our product, which can protect products from being scratched in the process of production and transportation, and you can choose to reserve or remove the film as needed.
- Place the refrigerator and adjust to level, clean it, let the refrigerator stand for above 2 ~ 6 hours, and then power on to ensure that the refrigerator can operate normally.

## Water supply connection

- **WARNING: Connect to potable water supply only.**
- **The water supply system must be installed and connected by a professional technician.**  
Connect the refrigerator with the cold water pipe:  
Min. pressure: 140Kpa( 1.4bar )  
Max. pressure: 690Kpa( 6.9bar)
- When using the function of ice maker, please make sure that the tap water pipe is connected normally and the water valve is opened. Enough space shall be reserved for the faucet connecting water source.
- After the refrigerator operates stably, the ice maker will make ice. Upon power-on for the first time, cold water is available after 5 hours since the refrigerator operates normally, and ice cubes or crushed ice is available after 12 hours.

## Starting

- Connect the power cord, and turn on the power switch.
- Upon startup for the first time, the screen will display respective set temperature values (the temperature of refrigerating chamber is set as 38°F, temperature of freezing chamber -2°F)

# Operation



Default is Fahrenheit when power is on.

Press "MODE" button 5 seconds, to switch between °C and °F.

Other buttons use the same method to switch between two modes.

## Set temperature range: Celsius degree mode

1. Fridge temperature range: 0~6 °C (Default value 3 °C)

2. Freezer temperature range: -23~-15 °C (Default value -19 °C)

## Set temperature range: Fahrenheit degree mode

1. Fridge temperature range: 32~43°F (Default value 38°F)

2. Freezer temperature range: -10~5°F (Default value -2°F)

### • CONTROL PANEL – CHILD LOCK

The CONTROL PANEL LOCK is designed to prevent any changes to the settings to the refrigerator.

**To enable the CHILD LOCK, press the LOCK button, the CHILD LOCK icon will turn on.**

**The control panel will be locked until unlocked at the control panel or there is a loss of power.**

**To disable the CHILD LOCK, press and hold the lock button for approximately 3 seconds until the LOCK icon turns off and the control panel is working in normal operation mode.**

### • CONTROL PANEL – STANDBY

The CONTROL PANEL will go dark after approximately 20 seconds of no activity.

To reactivate the display, simply press any of the buttons on the control panel.

## ➤ Setting the Temperature Control

- Your unit has one control for regulating the temperature. The temperature control is located on the outside of the refrigerator compartment door.
- The first time you turn the unit on, the unit will start at the factory-set default temperature, which is 38°F in the refrigerator compartment and -02°F in the freezer compartment.
- The first time you turn the unit on, adjust the temperature in the refrigerator compartment to 34°F and run for at least 4 hours before placing food inside. This will ensure that the freezer compartment is thoroughly chilled and the refrigerator compartment is stabilized before food is placed inside. Then adjust the temperature setting to your desired setting.
- To adjust the temperature in each zone, press the appropriate zone button, and the selected zone will flash on and off. The temperature will change according to the pre-set temperatures as shown below. You will hear a bell chime with each press of the control panel buttons.



# Operation

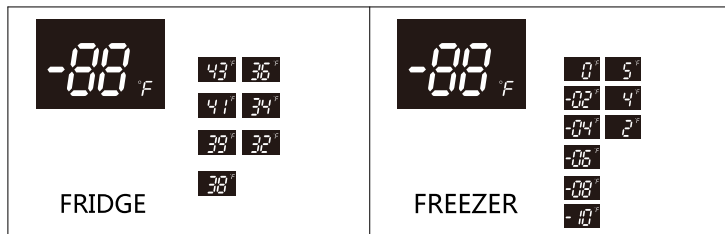

## PRE-PROGRAMMED FUNCTIONS:

- **FAST FREEZE MODE**



This mode will set the freezer temperature to -10°F for a quick drop in temperature when storing large amounts of warm or room-temperature foods in the freezer.

The unit will remain in FAST FREEZE mode for 24 hours or until the temperature reaches -10°F and will then return to the original setting, or until the function is turned off at the control panel. FAST COOL and FAST FREEZE can be run simultaneously.

To enable the FAST FREEZE mode, press the feature button until the FAST FREEZE icon is illuminated. The icon will remain illuminated when activated.

To disable the FAST FREEZE mode, press the function button until the FAST FREEZE icon is turned off.

- **FAST COOL MODE**



This mode will set the refrigerator temperature to 32°F for quick drop in temperature when storing large amounts of warm or room temperature foods in the refrigerator.

The unit will remain in FAST COOL mode for 2 hours and 30 minutes or until the temperature reaches 32°F and will then return to the original setting, or until the function is turned off at the control panel. Both FAST COOL and FAST FREEZE can be run together at the same time.

To enable the FAST COOL mode, press the feature button until the FAST COOL icon is illuminated. The icon will remain illuminated when activated.

To disable the FAST COOL mode, press the function button until the FAST COOL icon is turned off.

- **VACATION MODE**



Use this mode when leaving for long periods of time, where you will remove the large majority of the refrigerator contents but leave contents in the freezer.

Vacation mode will automatically set the refrigerator section to 43°F and the freezer section to 5°F. The unit will remain in VACATION MODE until the feature is deactivated at the control panel.

To enable VACATION mode, press the feature button until the VACATION icon is illuminated. The icon will remain illuminated when activated.

To disable VACATION mode, press the function button until the VACATION icon is turned off.

# Operation

**NOTE:**

- IF THE UNIT IS UNPLUGGED, HAS LOST POWER, OR IT IS TURNED OFF. YOU MUST WAIT 3 TO 5 MINUTES BEFORE RESTARTING THE UNIT. IF YOU ATTEMPT TO RESTART BEFORE THIS TIME DELAY, THE REFRIGERATOR-FREEZER WILL NOT START.

**NOTE:**

**WE DO NOT RECOMMEND INSTALLING THE REFRIGERATOR WHERE THE TEMPERATURE WILL DROP BELOW 32°F (0°C) OR RISE ABOVE 110°F (43°C). THE COMPRESSOR WILL NOT BE ABLE TO MAINTAIN PROPER TEMPERATURES INSIDE THE REFRIGERATOR.**

**FOR INSTALLATIONS WHERE THE TEMPERATURES WILL DROP BELOW 32°, SET THE FREEZER TEMPERATURE CONTROL TO THE "COLDEST" SETTING. THIS WILL IMPROVE THE FUNCTIONING THE REFRIGERATOR UNDER THESE CONDITIONS.**

# Operation

## Refrigerator chamber

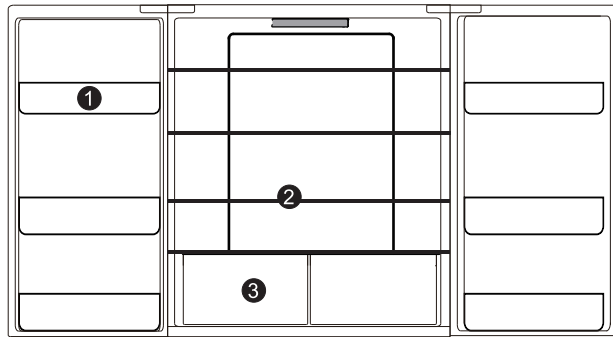

**The refrigerator chamber is mainly used to store foods that are preserved for a short time.**

- The refrigerator chamber is suitable for storing fruits, vegetables, drinks and other foods that will be eaten recently. It is suggested to seal foods and then put them into the refrigerator.

Suggested sections of refrigerator chamber for various foods and variety name:

- ① Top tray: dairy products, odorous foods, etc.;
- ② Glass shelf: wheaten foods, milk, etc.;
- ③ Drawer: fruits, vegetables, etc.;

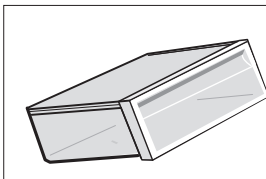

### ■ Fruit and vegetable box

The refrigerating chamber has a fruit and vegetable box, which can retain the moisture of fruits and vegetables and keep the humidity of the box proper. It is suitable for storing fruits and vegetables.

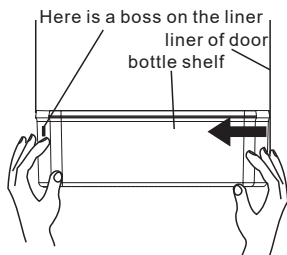

### ■ Bottle Shelf

**Disassembly:** Hold both sides of the bottle shelf with both hands. Push it from the side without the boss and push it inward as the direction of the arrow. When pushing hard, please note that the buckle on the edge of bottle shelf is separated from the groove of the liner. Then bottle shelf can be removed.

**Installation:** Hold both sides of the bottle shelf with both hands. Install the buckle of the boss side at first. Then push the other side inward slightly, the buckle can be fixed.

# Operation

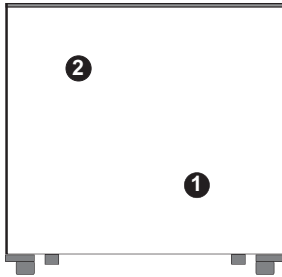

- **The freezing chamber is used to freeze foods, store deeply frozen foods and make ice cubes. It can preserve foods for a long time.**

The freezing chamber is suitable for retaining the freshness of foods for a long time. When storing meat, it is suggested to cut the meat into pieces which are easy to take out, and mark the freezing date to prevent foods from exceeding the time limit.

Suggested sections of freezing chamber for various foods and variety name:

- ① Drawer: packaged frozen foods, etc.;
- ② Ice maker.

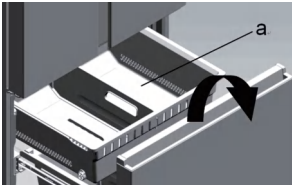

- **Drawer of freezing chamber**

The upper drawer of freezing chamber can freeze and store large-volume foods, and the lower drawer is mainly used to store frozen foods.



## CAUTION

The food especially the oily food which stored in refrigerator, please avoid the direct contact with the liner. When the interior stained with oil or oily food soup stains, should be cleaned immediately to avoid the long contact with the liner which may lead to the liner corrosion and cracking.

# Operation

## Storage of foods



### CAUTION

#### Instructions for storing foods

- When storing freezing foods, put them to the inside of freezing chamber, other than the bottle rack.
- Do not put bottled or canned foods into the freezing chamber to prevent frost cracking.
- Before putting hot foods into the refrigerator, cool them to room temperature first; otherwise, they will increase power consumption.
- Mark the freezing date on the packaging bag according to different storage lives of foods, so as to prevent foods from exceeding the time limit.
- Divide foods into proper pieces and package them separately, which are easy to freeze thoroughly and will not frozen together.
- The packaging materials shall be odorless, airtight, watertight and pollution-free, so packaged foods are not easy to taint by other odor, without quality reduction.
- Do not put too many fresh foods into the freezing chamber once, preferably not exceeding the freezing capacity value of refrigerator.
- Melted foods can not be frozen again, unless they are made into dishes; otherwise, their service quality will be affected.
- Glass bottles or glass containers shall not be placed into the freezing chamber or at the air outlet of refrigerating chamber duct; otherwise, they may explode.
- Foods can not block the air outlet; otherwise, abnormal air circulation will be caused.

## Energy saving tips

- Make sure to keep the refrigerator away from heat source and direct sunlight.
- Before storing hot foods, cool them to room temperature and then put into refrigerator.
- Close the door timely, reduce the opening frequency, and shorten the opening time.
- When unfreezing frozen foods, you can put them into the refrigerating chamber, which will assist in refrigeration of the refrigerating chamber.
- Make sure that the temperature sensor is not covered or blocked by foods, and keep proper distance with foods.

# Maintenance

## Defrosting

**This production has automatic defrosting function, without manual operation.**

## Cleaning

### **Precautions for internal and external cleaning of refrigerator:**

- Before cleaning, always turn off the power switch, disconnect the power plug.
- During cleaning, make sure that no water will enter the switch, control panel, door lamp and top control box.
- Remove dirt from the outside of refrigerator with mild cleaner, then wipe with clean soft cloth, and let the refrigerator dry naturally.
- When cleaning door sealing strip, always use clean water, wipe with dry cloth and let it dry naturally. Wet soft cloth with warm water or neutral cleaner to wipe the refrigerator body except the door sealing strip.
- It is forbidden to flush the refrigerator directly with water, which will affect electrical insulation properties, etc.
- It is forbidden to clean the refrigerator with metal wipers, ware brushes, coarse abrasive cleaners, strong alkaline detergents, or flammable or toxic cleaning fluids.

**After cleaning, connect the power plug of refrigerator, and connected with the refrigerator.**

## General information

### **On vacation**

- When you want to leave for vacation, you had better to make the refrigerator operate continuously and leave foods that can be stored for a short time. If you want to stop the refrigerator, remove all foods, disconnect the power plug, clean the inside of refrigerator fully, and open the door to avoid producing abnormal odors.

### **At power failure**

- Generally, short-term power failure will not affect the temperature of the refrigerator sharply. However, if power failure lasts for a long time, you shall reduce the opening frequency of refrigerator, and shall not put fresh foods into the refrigerator (prevent rise in the temperature of refrigerator from speeding up).
- If you know power failure is coming, you can turn on the “Super Freezer” function in advance to keep the temperature of refrigerator to the lowest value.

### **Shutdown**

- Generally, it is not suggested to stop refrigerator or turn off the power switch; otherwise, the life of refrigerator may be affected.

# Maintenance

## Normal phenomena

### ■ **Button failure**

Please check the control board whether the fridge under lock mode. When under lock mode, all buttons can't work.

### ■ **Low voltage, the compressor can't start**

You should purchase pressurizer of more than 1000W when the area of the appliance installation, that's better to protect your fridge.

### ■ **Long time to start**

When the ambient temperature too high, it will take long time to start the appliance.

### ■ **Middle beams feel hot**

Middle beams feel hot after a period of time of the appliance run, it belongs to the normal phenomenon.

### ■ **Dew drops**

When external air flows into the cool inner surface of the fridge, dew drops can be formed.

If the humidity of the installed location is high or during the rainy season, dew drops can form on the outer side of the fridge. This is a natural phenomenon that occurs during the humid weather, Wipe the water drops with a dry cloth.

### ■ **Noise**

When you operate the fridge for the first time, the fridge will operate at high speed to cool fast and the sound can seem louder. When the internal temperature falls below a certain level, the noise will subside.

When the operation of the compressor is starting or ending; various parts expanding/contracting or various control devices operating or temperature change within the fridge, you will hear the sounds, these are normal sounds.

### ■ **Compressor hot**

When working, the temperature of the compressor outer is more than 80℃, please do not touch the compressor, it may cause serious injury.

### ■ **Compressor long time running**

When the ambient temperature too high or put too much fresh foods into the fridge, it will take long time to cool down until the appliance run at the setting temperature.

# Maintenance

## Trouble shooting

Before calling for service, review this list. It may save you both time and expense. This list includes common occurrences that are not the result of defective workmanship or materials in this appliance.

Fault	Possible cause	Remedial action
No display on the display panel	The mains plug of the appliance is not in the socket properly.	Check whether the power is on;
Alarm sound	Door is slightly open or not close more than 1 minute.	Close the door completely.
The compressor do not work	It' s under defrosting mode. Power is not connected well.	It' s normal for defrosting; Check whether the power is connected well.
Compressor runs too long	The fridge has recently been dis- connected for a period of time; Put too much fresh or hot food; Doors are opened too frequently or too long.	It takes some hours for the fridge to cool down completely; Hot food will cause the fridge to run longer until the desired temperature is reached; Warm air entering the fridge cause it to run longer. Open the door less often.
Vibrating noise	Floor is uneven or weak; Items placed on the top of the fridge are vibrating; Fridge is touching wall or cabinets.	Be sure floor is level and solid and can adequately support fridge; Remove items; Move fridge so that does not touch the wall or cabinets;



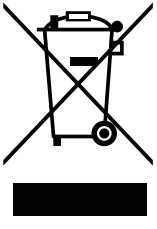

This symbol on the product or in its packing indicates that this product may not be treated as household waste. Instead, it should be taken to the appropriate waste collection point for the recycling of electrical and electronic equipment. By ensuring this product is disposed of correctly, you will help prevent potential negative consequences for the environment and human health, which could otherwise be caused by the inappropriate waste handling of this product. For more detailed information about the recycling of this product, please contact your local council, your household waste disposal service, or the shop where you purchased the product.

**VEZENI**  
vezeni.com